

# **Design and Construction of a Variable Gain Amplifier for Tunable Diode Laser Spectroscopy**

**Robert Moffatt**

Thomas Jefferson High School for Science and Technology

Laboratory:NRL

Mentor: Dr. James W. Fleming

# Introduction

- My project supported research done by Dr. James Fleming and Dr. Andy Awtry.
- They are investigating how the displacement of oxygen by the evaporation of water mist can be used to put out fires.

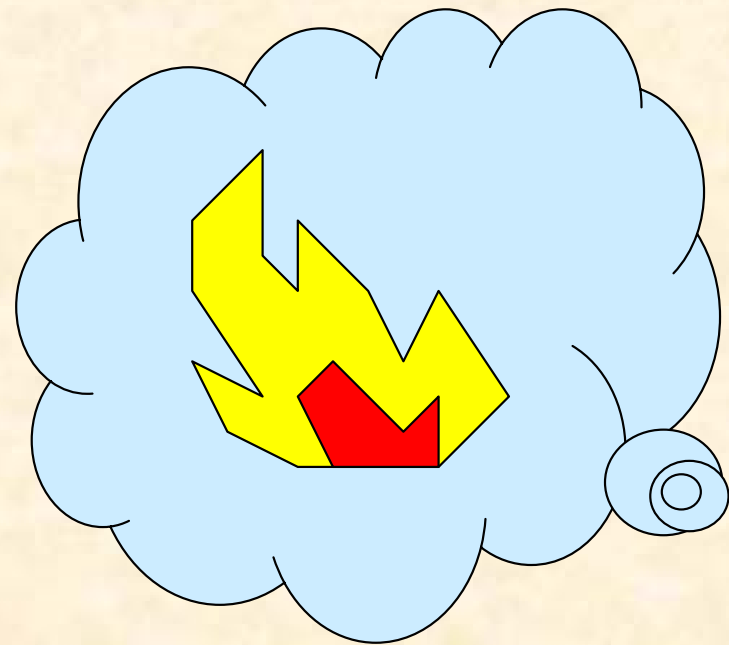

# Experiment Setup

- 760nm laser beam sent through air near flame.
- Photodiode measures light intensity
- Signal amplified and sent to computer

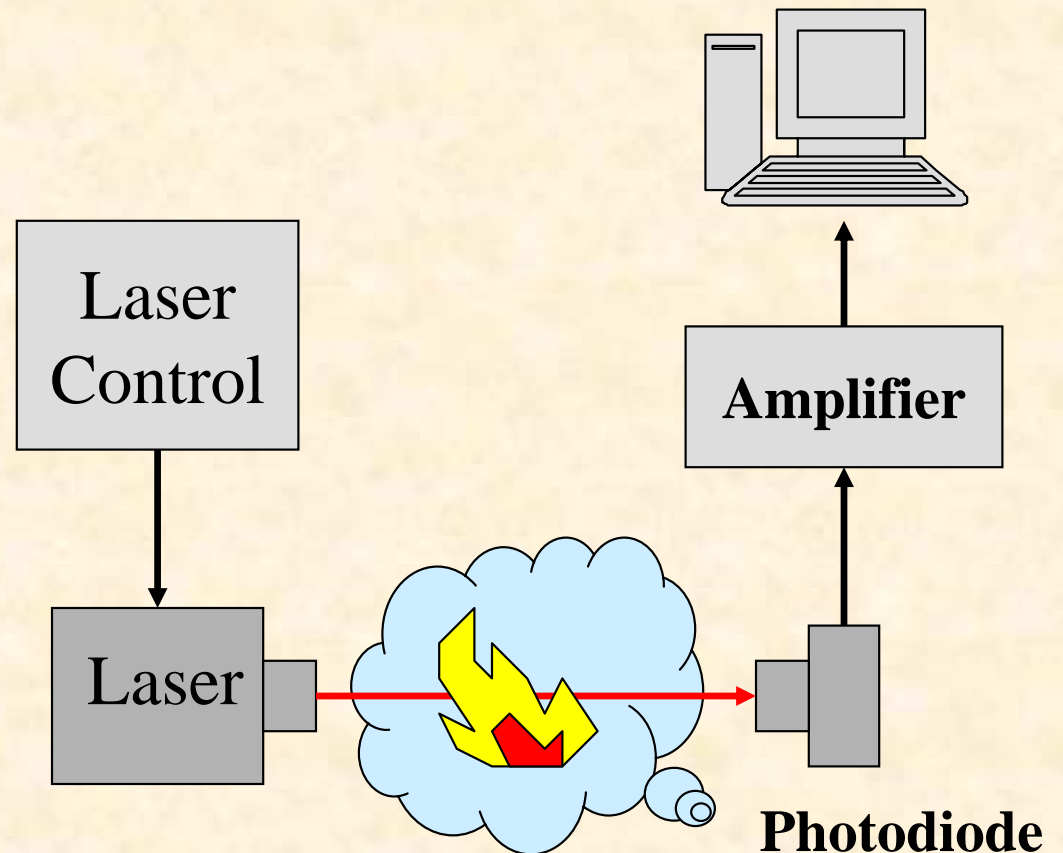

# The Signal

- Laser current follows a 2KHz triangle wave.
- Wavelength and intensity sweep up and down with current.

Light Output  
from Laser:

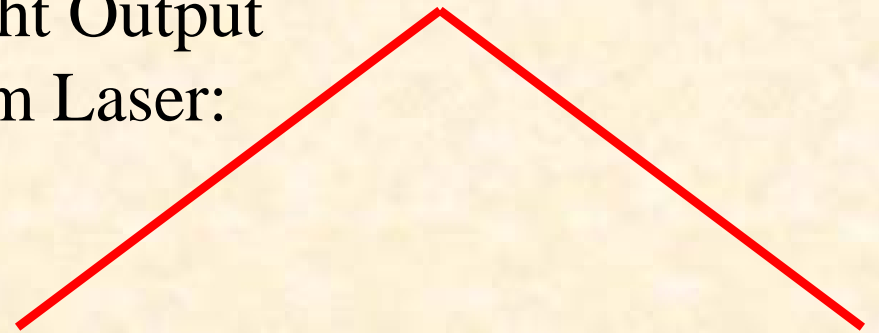

Light Input to  
Photodiode:

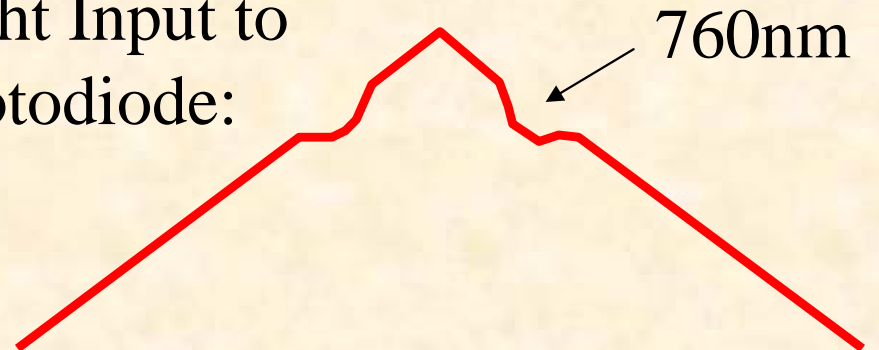

# Attenuation by Mist

- Relative amplitude of absorption line unaffected by mist.
- Mist does affect absolute amplitude of signal.
- Amplification is required to keep the signal above the noise level.

Without  
Mist:

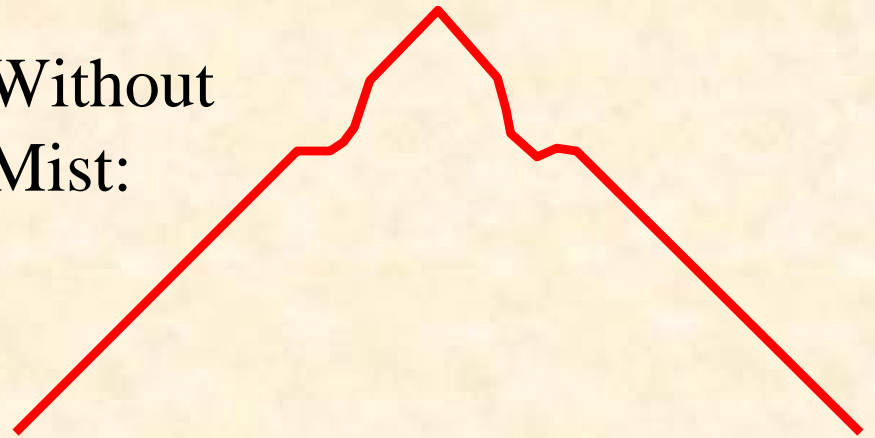

With Mist:



# Attenuation by Mist

- Attenuation caused by mist varies over three orders of magnitude.
- No single gain setting on the amplifier allowed the entire range to be measured.
- I designed and constructed circuits to solve this problem: an amplifier with multiple gains, and an amplifier with automatically controlled gain.

# Multiple-Gain Amplifier

- This multiple-gain amplifier circuit was designed by Dr. Volker Ebert.
- One input and three outputs.
- The outputs are monitored simultaneously, so the computer is always provided with at least one acceptable signal.

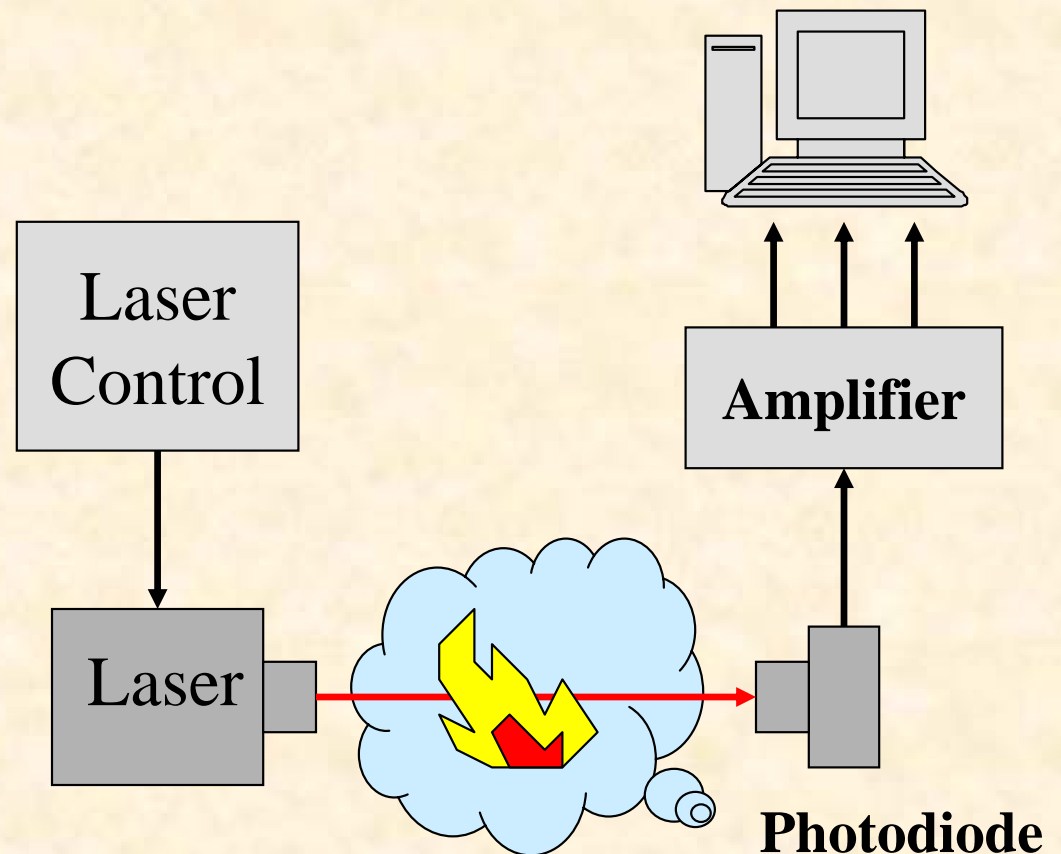



## The Schematic

- The gain of each output can be switched between two settings: 3 or 6, 10 or 40, and 30 or 250.
- The circuit uses three OP27 and OP37 op amps

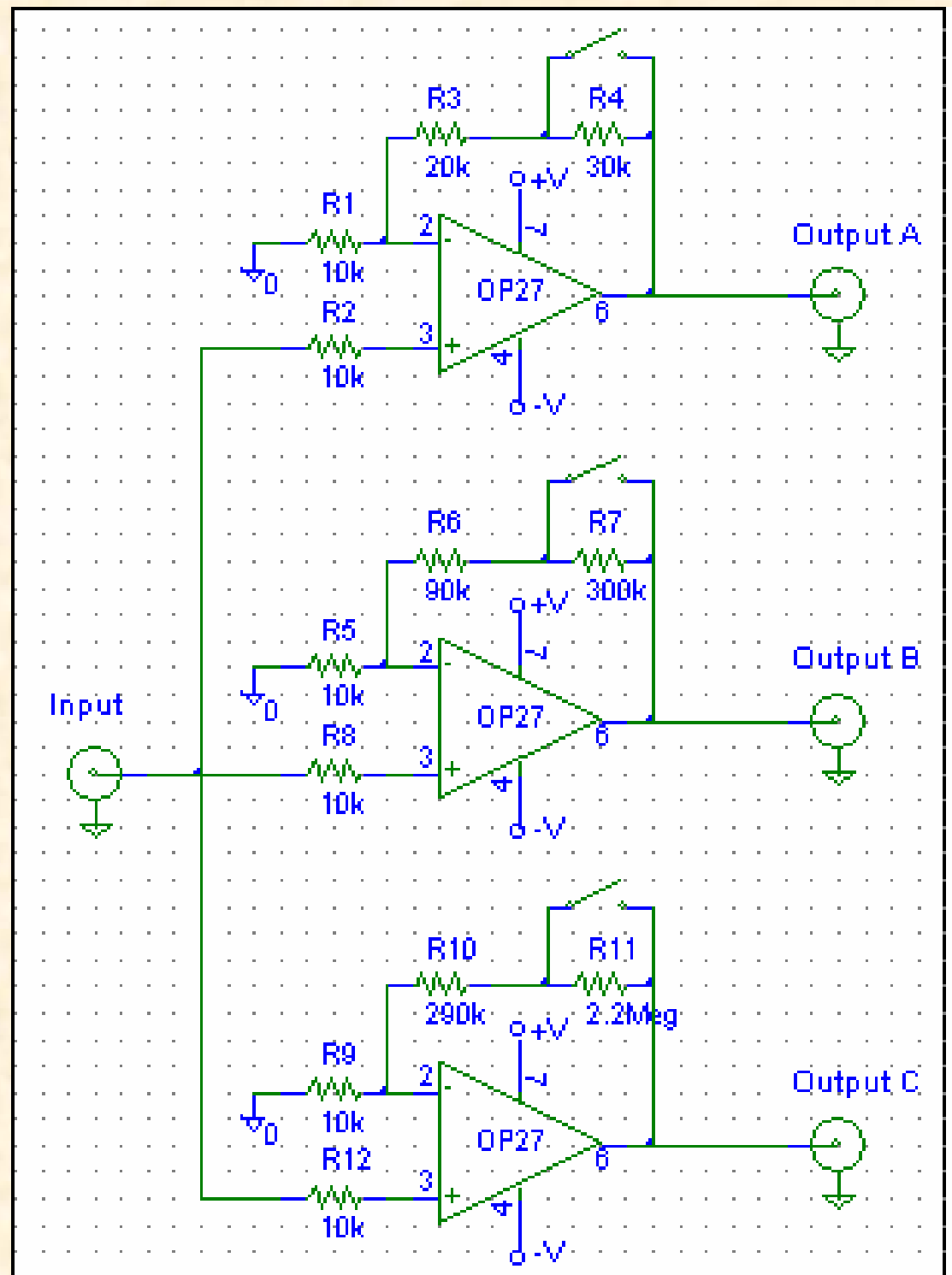



# Auto-Gain Amplifier

- Gain controlled automatically
- Output measured once per cycle
- Circuit determines if its gain should increase, decrease, or remain the same

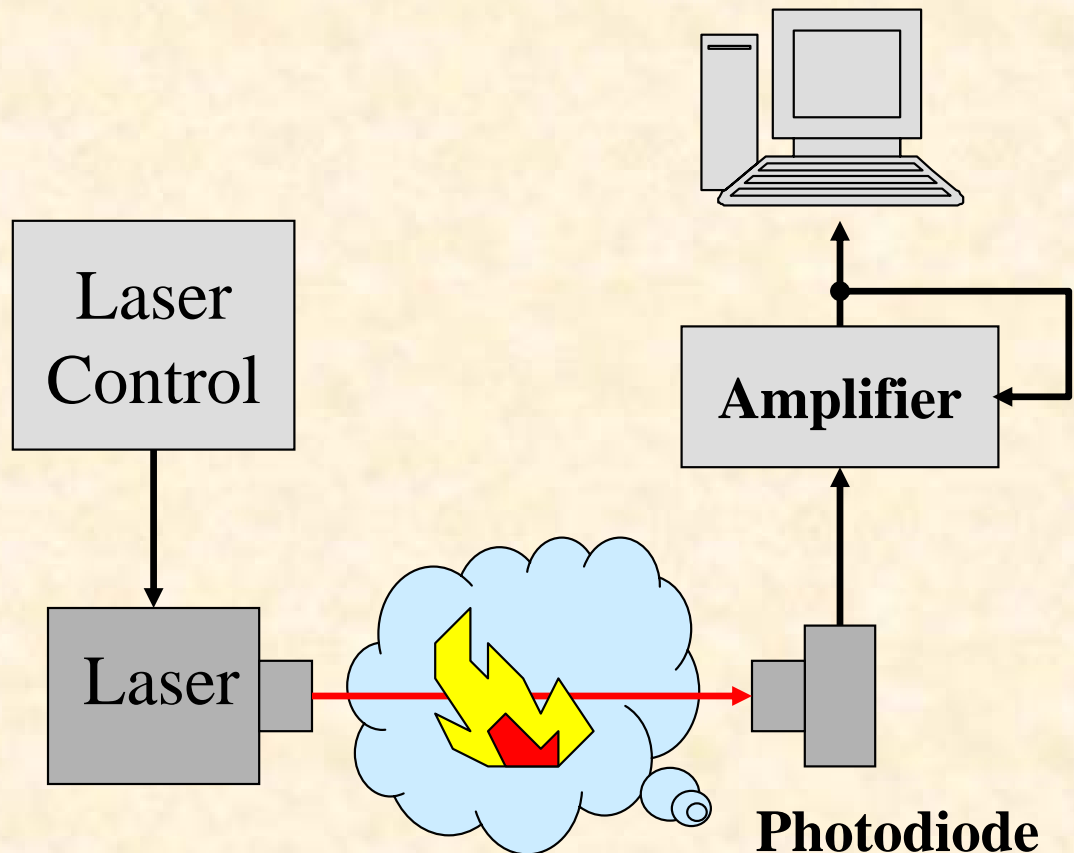

# Block Diagram:

- The circuit consists of three modules:
  - A digitally controlled amplifier
  - A sampling circuit
  - Control circuitry

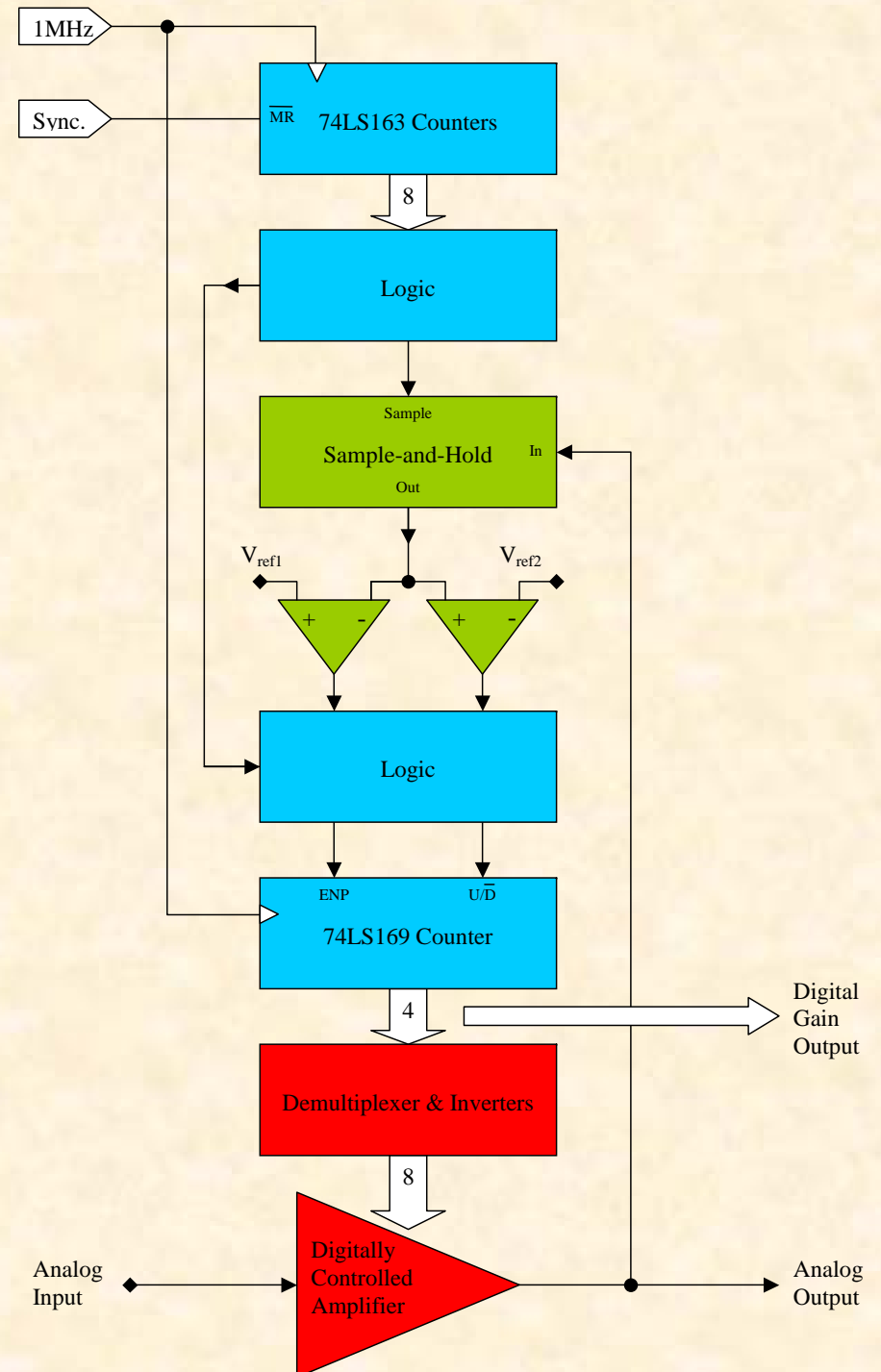

# Results: Multiple-Gain Amplifier

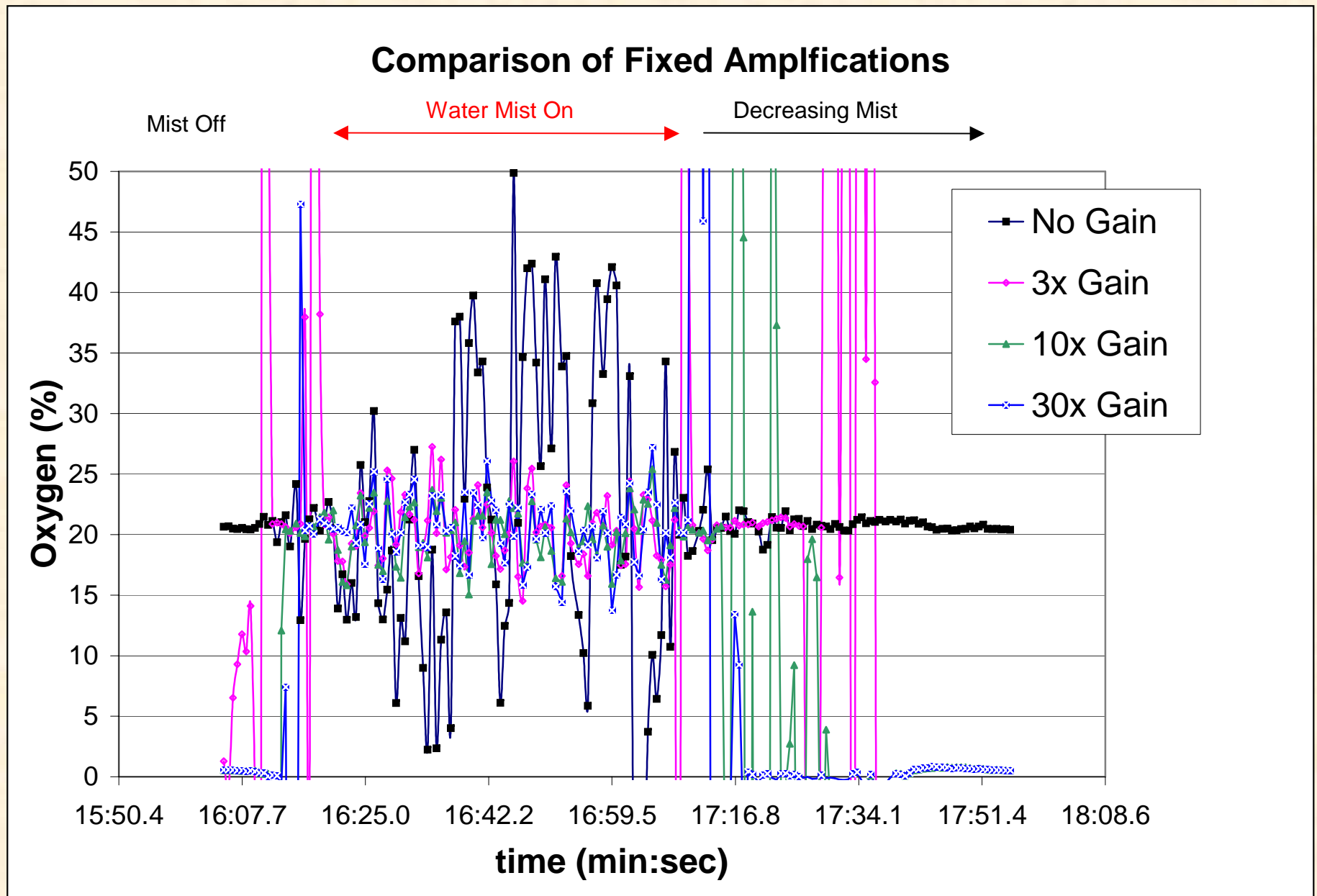

- A LabView program was used to record and analyze the data.
- % O<sub>2</sub> is constant; fluctuations are due to noise

# Results: Auto-Gain Amplifier

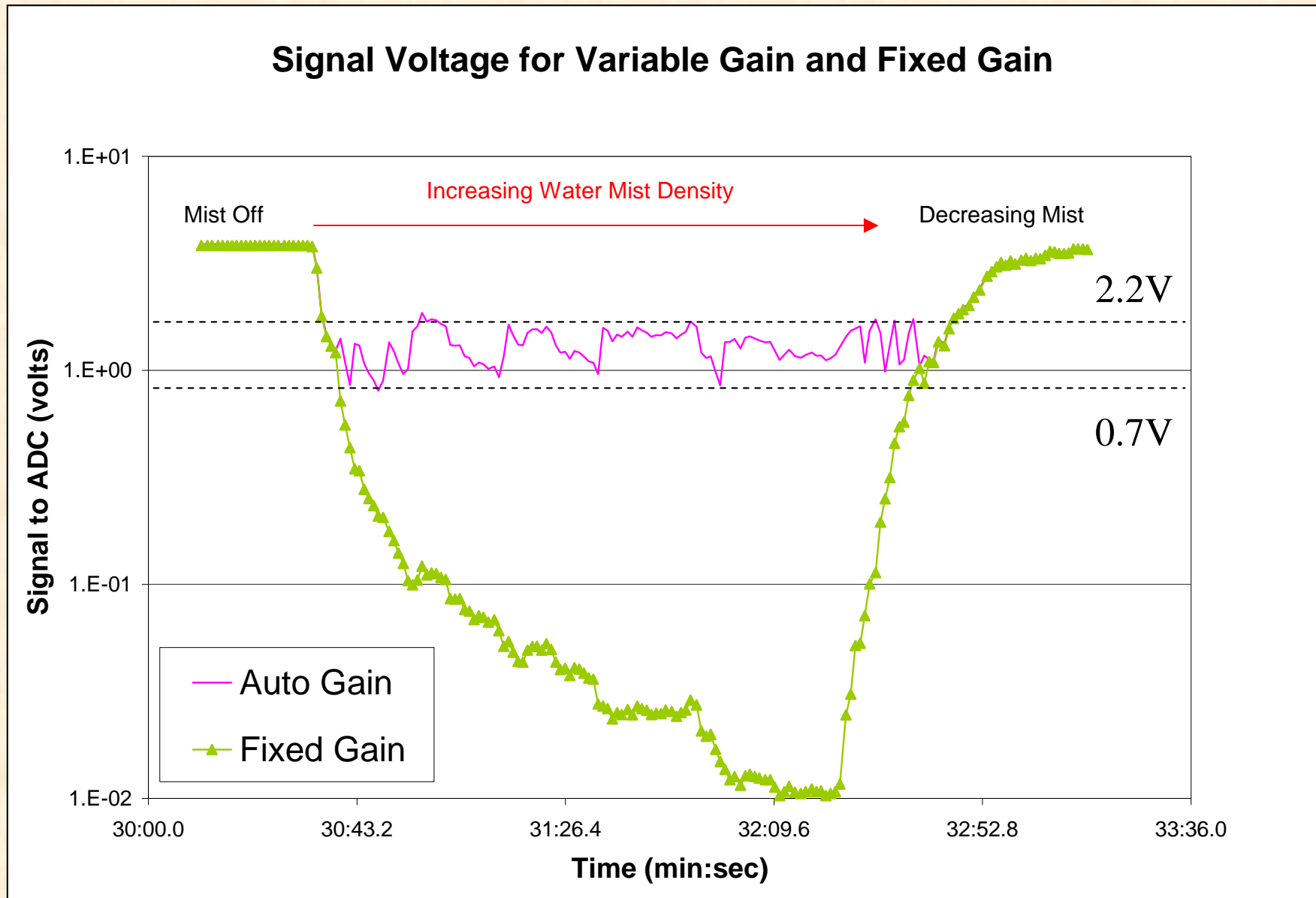

- Input signal varied over 2.5 orders of magnitude.
- Signal level maintained within predetermined limits

# Results: Auto-Gain Amplifier

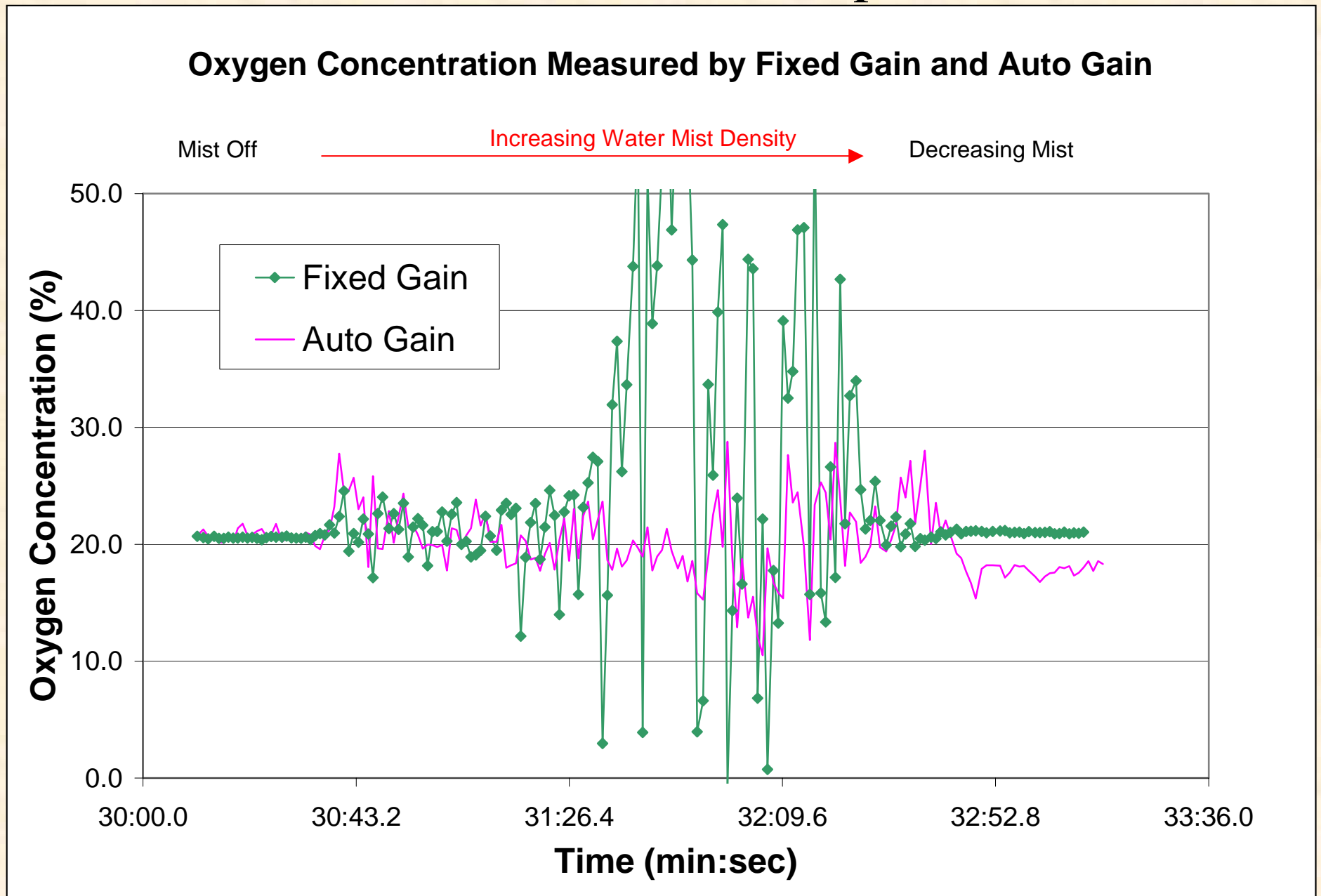

- Allowed % O<sub>2</sub> measurements to be made in high mist densities.

# Conclusion

- The Multiple-Gain Amplifier was successful. It allowed valid O<sub>2</sub> concentration measurements to be taken during periods of high mist density.
- The Auto-Gain Amplifier was successful in controlling the gain and providing valid O<sub>2</sub> concentration measurements.

# Acknowledgements

- Dr. Fleming (NRL Mentor)
- Dr. Awtry (NRC/NRL Postdoctoral Fellow)
- Dr. Ebert (Visiting Professor, University of Heidelberg)